

Rotary Switches Type 04

- 24 position switch
- life expectancy
> 25 000 switching cycles
- steel spindle-shaft and metal bush for rugged applications
- modular system allows easy adaptation of standard products
- gold flash contact standard



With solder eyelets

SW = key spanner

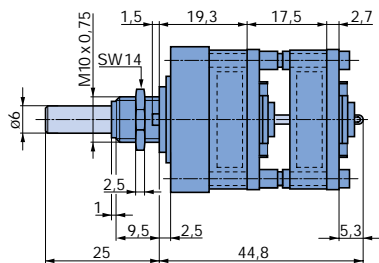

Drilling diagram for indexing angle 15°

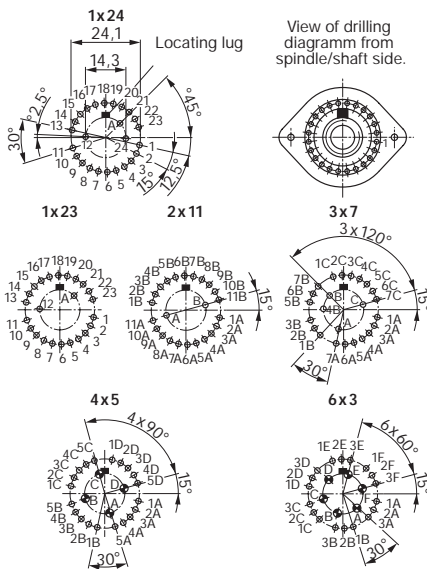

With solder pins for PCB mounting

Front panel cut out

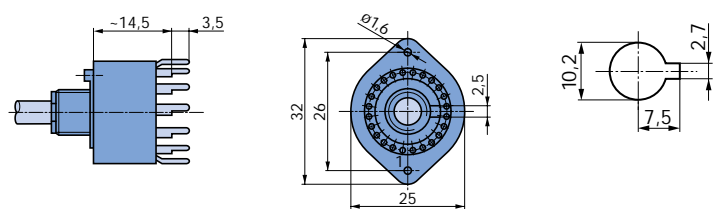

Drilling diagram for indexing angle 30°

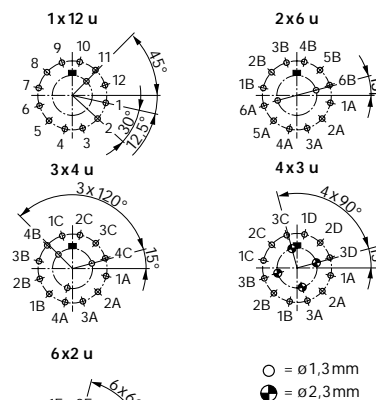







Possible modifications on request

- special type of shaft
(length, diameter, form)
- special torque
- waterproof
- special end stop
- shortened bush
- hollow shaft/inner shaft

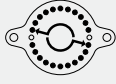



Stop screws M 1,4	(package of 10 pieces)	4124-21
Stop screws M 1,4	(package of 100 pieces)	4124-20
Bushing Nut	(package of 10 pieces)	4124-41

Indexing angle 15°, shorting (non-shorting on request)

Contact arrangement	Construction	Function (Pole x Position)	with solder eyelets		with pins for PCB	
			gold flash	gold 3 µm	gold flash	gold 3 µm
	1—H	1 x 24 o.A.	04-1100	04-1103	04-1100-20	04-1103-20
	2—HH	2 x 24 o.A.	04-2100	04-2103	-	-
	3—HHH	3 x 24 o.A.	04-3100	04-3103	-	-
	4—HHHH	4 x 24 o.A.	04-4100	04-4103	-	-
	1—H	1 x 24	04-1130	04-1133	04-1130-20	04-1133-20
	2—HH	2 x 24	04-2130	04-2133	-	-
	3—HHH	3 x 24	04-3130	04-3133	-	-
	4—HHHH	4 x 24	04-4130	04-4133	-	-
	1—H	2 x 11	04-1210	04-1213	04-1210-20	04-1213-20
	2—HH	4 x 11	04-2210	04-2213	-	-
	3—HHH	6 x 11	04-3210	04-3213	-	-
	4—HHHH	8 x 11	04-4210	04-4213	-	-
	1—H	3 x 7	04-1370	04-1373	04-1370-20	04-1373-20
	2—HH	6 x 7	04-2370	04-2373	-	-
	3—HHH	9 x 7	04-3370	04-3373	-	-
	4—HHHH	12 x 7	04-4370	04-4373	-	-
	1—H	4 x 5	04-1450	04-1453	04-1450-20	04-1453-20
	2—HH	8 x 5	04-2450	04-2453	-	-
	3—HHH	12 x 5	04-3450	04-3453	-	-
	4—HHHH	16 x 5	04-4450	04-4453	-	-
	1—H	6 x 3	04-1630	04-1633	04-1630-20	04-1633-20
	2—HH	12 x 3	04-2630	04-2633	-	-
	4—HHHH	18 x 3	04-3630	04-3633	-	-
	3—HHH	24 x 3	04-4630	04-4633	-	-

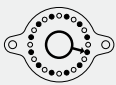
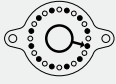
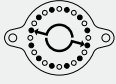
packing unit : 10 pieces

Indexing angle 30°, non-shorting

Contact arrangement	Construction	Function (Pole x Position)	with solder eyelets		with pins for PCB	
			gold flash	gold 3 µm	gold flash	gold 3 µm
	1—H	1 x 12 u.o.A.	04-1101	04-1104	04-1101-20	04-1104-20
	2—HH	2 x 12 u.o.A.	04-2101	04-2104	-	-
	3—HHH	3 x 12 u.o.A.	04-3101	04-3104	-	-
	4—HHHH	4 x 12 u.o.A.	04-4101	04-4104	-	-
	1—H	1 x 12 u.	04-1121	04-1124	04-1121-20	04-1124-20
	2—HH	2 x 12 u.	04-2121	04-2124	-	-
	3—HHH	3 x 12 u.	04-3121	04-3124	-	-
	4—HHHH	4 x 12 u.	04-4121	04-4124	-	-
	1—H	2 x 6 u.	04-1261	04-1264	04-1261-20	04-1264-20
	2—HH	4 x 6 u.	04-2261	04-2264	-	-
	3—HHH	6 x 6 u.	04-3261	04-3264	-	-
	4—HHHH	8 x 6 u.	04-4261	04-4264	-	-
	1—H	3 x 4 u.	04-1341	04-1344	04-1341-20	04-1344-20
	2—HH	6 x 4 u.	04-2341	04-2344	-	-
	3—HHH	9 x 4 u.	04-3341	04-3344	-	-
	4—HHHH	12 x 4 u.	04-4341	04-4344	-	-
	1—H	4 x 3 u.	04-1431	04-1434	04-1431-20	04-1434-20
	2—HH	8 x 3 u.	04-2431	04-2434	-	-
	3—HHH	12 x 3 u.	04-3431	04-3434	-	-
	4—HHHH	16 x 3 u.	04-4431	04-4434	-	-
	1—H	6 x 2 u.	04-1621	04-1624	04-1621-20	04-1624-20
	2—HH	12 x 2 u.	04-2621	04-2624	-	-
	3—HHH	18 x 2 u.	04-3621	04-3624	-	-
	4—HHHH	24 x 2 u.	04-4621	04-4624	-	-
PCB wafer switch	1—H	0 - 9 BCD u.				04P1913

Contact arrangement from the spindle side u. = non-shorting, o.A. = without end stop, can not be adjusted subsequently!

packing unit : 10 pieces

1 mm = 0.04 inch, 1 inch = 25.4 mm